













KENIA-110D VISION

©Bronpi Calefacción, S.L. reserves all rights to the images that appear in this document. You may not reproduce or distribute part or all of the photographs and as the text. Both the brand as distinctive symbols are the exclusive property of the company. All rights will be prosecuted according to law.



 SCL	 SSV									 kW
 66	 6,1	 575	 163	 250	 2x120	 4x160	 960x265x450	 92		23
 A										
M-21 M-22 M-29 M-30										

Features

- Clean Glass System
- Security System in Fans
- Heating power: 23kw
- Efficiency (%): 66%
- Consumption (kg/h): 6,1kg/h
- Heating capacity (m3): 575m3
- Vermiculite inside
- Manufactured in sheet
- Weight (kg): 163kg
- Smoke exit tube diameter (mm): 250mm
- Air channel (diameter and exit tube number): 2x120
- Forced ventilation: 4x160
- Useful chamber measures: 960x265x450mm
- Maximum logs size (cm): 92cm
- Compatible accesories not included: M-21; M-22; M-29; M-30

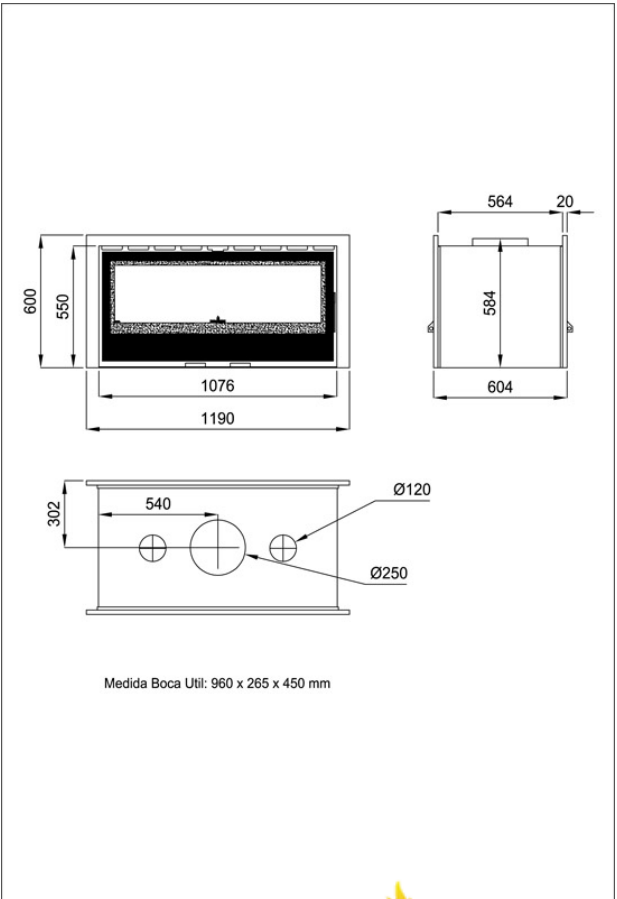

Given the continued improvement of our products and improving our manufacturing process, size, aesthetics and product specifications are subject to change without prior notice from our company.

www.bronpi.com

