







HUESCA



 SDC
  SCL
  kW 13

 77
  3,7
  325
 

 106
  150
  608x313x303
  64

Características

- Sistema Dupla Combustão
- Sistema Cristal Limpo
- Potência de aquecimento: 13kw
- Rendimento (%): 77%
- Consumo (kg/h): 3,7kg/h
- Volume de aquecimento (m3): 325m3
- Interior vermiculite
- Fabricado em fundição e aço
- Peso (Kg): 160kg
- Diâmetro saída de fumos (mm): 150mm
- Medidas da camara: 608x313x303mm
- Tamanho máximo dos troncos (cm): 64cm

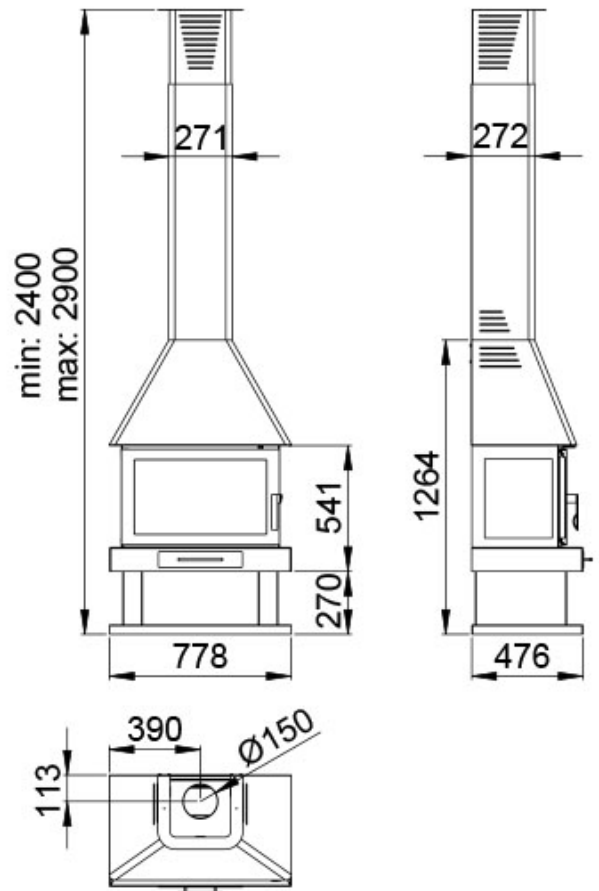

Dada a melhoria contínua de nossos produtos e melhorar o nosso processo de fabricação, tamanho, estética e especificações de produtos estão sujeitos a alteração sem aviso prévio da nossa empresa.

www.bronpi.com



© Bronpi Calefacción, S.L. reserva todos os direitos das imagens que aparecem neste documento. Você não pode reproduzir ou distribuir parte ou a totalidade das fotografias e do texto. Tanto a marca como símbolos distintivos são de propriedade exclusiva da empresa. Os infratores serão punidos conforme a lei.